



Wide Format Photo Laser Printer

Revision E · February 2002



Océ Display Graphics Systems

© 2002 ALL RIGHTS RESERVED

Table of Contents

Copyright and Document History	iii
Product Support, Documentation and Service	iii
Product Compliance and Standards	v
1 Introduction to the LightJet® 430	1-1
Important Safety Information For All Users.....	1-1
Getting Familiar With Your LightJet® 430.....	1-2
Overview.....	1-2
Features.....	1-3
Supported Media Specifications.....	1-3
2 Operating the LightJet® 430	2-1
Powering On and Off.....	2-1
Media Handling.....	2-1
Control Panel	2-2
Activating Options.....	2-3
Media Menu.....	2-4
Load New Roll	2-4
Advance Media.....	2-8
Cut and Unload.....	2-9
Setup Menu.....	2-10
Motor Control.....	2-10
Video Control	2-10
Internal Plot	2-10
Debug Mode.....	2-11
Download Firmware	2-11
Cleaning Mode.....	2-11

List of Figures

Figure 1-1. Exterior view.....	1-2
Figure 2-1. Control panel.....	2-2
Figure 2-2. Attaching spool flanges to a media roll.....	2-4
Figure 2-3. Loading media.	2-5
Figure 2-4. Pinch lever.....	2-6

List of Tables

Table 1-1. LightJet 430 laser specifications.....	1-1
Table 1-2. Supported media dimensions.	1-3
Table 2-1. Functions of the control panel keys.....	2-3

Copyright

© 2002 Océ Display Graphics Systems. All rights reserved.

This document contains information proprietary to Océ, to its subsidiaries, or to third parties to which Océ may have a legal obligation to protect such information from unauthorized disclosure, use or duplication. Any disclosure, use, or duplication of this document or of any of the information contained herein for other than the specific purpose for which it was disclosed is expressly prohibited, except as Océ may otherwise agree to in writing. Due to continuing research and product improvements, features or product specifications may change at any time without notice.

Document History

Date	Release	Doc. No.	Revision	Revision Summary
April 4, 2001	Production	45573	C	Additional compliance information; new manual format.
Jan. 18, 2002	Production	45573	D	All Gretag references changes to Océ.
Feb. 13, 2002	Production	45573	E	Added info that manual also covers LightJet 430RS.

Product Support, Documentation and Service

For further information on documentation and support for your LightJet® 430 or for information on other Océ Display Graphics Systems products, please contact:

Océ Display Graphics Systems
13231 Delf Place, #501
Richmond, British Columbia, Canada V6V 2C3
Phone: (604) 273-7730 Fax: (604) 273-2775
Web: <http://www.dgs.oce.com>
FTP Site: <http://www.symbolic.com/ftp.html>

Comments on this manual?

Please forward to the above address, marked “Attention: Technical Writer”.

Océ maintains a comprehensive support structure for its LightJet® customers. Upon installation of your printer, you will be provided with the name of the sales and service office responsible for your account. Record this information, along with the serial number of your LightJet 430. Always report service problems to the office assigned to your account at installation. Contacting the factory directly may cause unnecessary delays in resolving your service issue.

US and Canadian Customers:

Océ Display Graphics Systems
13231 Delf Place, Building #501
Richmond, British Columbia, Canada
V6V 2C3

Service: 1-800-456-3473
Fax: 604-232-3154

European Customers:

Océ Display Graphics Systems
6 Waltham Park
Waltham Road
White Waltham
Berkshire SL6 3TN
England

Service: 44-0-1628-519588
Fax: 44-0-1628-519589

Asia Pacific Customers:

Océ Display Graphics Systems
Grand Palace Tamachi 601
4-9-18 Shibaura, Minato-ku
Tokyo, Japan 108-0023

Service: 81-3-5484-8033
Fax: 81-3-5484-2071

Other:

Your regional distributor

When you call one of our customer service numbers you will be provided with telephone technical support. Outside of office hours, you can leave a message and your call will be returned the next working day. When you call, identify yourself as a LightJet® customer and provide the following information:

- The serial number of your LightJet 430
- Your company name
- Your name
- Your telephone number
- Nature of the problem

If we are unable to resolve your problem over the telephone, field engineers can be dispatched to your site to conduct repairs. Service visits are paid for by the customer, either under a maintenance agreement or by purchase order or prepayment. Time and material rates are charged for any service not covered under a maintenance agreement. Before calling to report a problem, gather as much information about the problem as possible and have it ready to provide to the customer care center engineer. The more information you can provide initially, the more quickly the problem can be corrected.

Product Compliance and Standards

Electromagnetic Compatibility

This equipment generates, uses and radiates radio frequency energy and if not installed and used as designed or intended, may cause interference to radio communications. This equipment has been tested and found to comply with the limits for a Class A computing device. This equipment has been designed to provide reasonable protection against such interference when operated in residential and commercial environments. Operation of this equipment in a residential area may cause interference, in which case the user, at his own expense, is required to take whatever measures are required to correct the interference.

United States Of America - FCC

This device complies with Part 15 of the FCC Rules. Operation is subject to the following two conditions: (1) This device may not cause harmful interference, and (2) This device must accept any interference received, including interference that may cause undesired operation.

Canada - ICES-003

This Class A/B digital apparatus meets all requirements of the Canadian Interference-Causing Equipment Regulations.

Cet appareil numerique de la classe A/B respecte toutes les exigences du Reglement sur le materiel brouilleur du Canada.

European Community - EMC

This device complies with Class A/B emission limits in accordance with EN55022.

Electromagnetic compatibility - Emissions	89/336/EEC
Electromagnetic compatibility - Immunity	89/336/EEC

Electrical Safety

This equipment has been tested and found to comply with the following electrical safety standards:

North America

Canada	CSA 950
United States of America	UL 1950

European Community

EN60950	Low Voltage Directive	73/23/EEC
EN60204-1	Machinery Directive	93/68/EEC

Laser Safety

This equipment is a Class 1 laser product which is safe under all operating conditions. The following standards were used to evaluate compliance:

<u>United States of America</u>	
Center for Devices and Radiological Health (CDRH)	21 CFR 1040
<u>Canada and European Community</u>	
Safety of Laser Products	EN60825-1

End of Section

1 Introduction to the LightJet® 430

This manual is applicable to both the LightJet 430 and LightJet 430RS printers. All references to the LightJet 430 also refer to the LightJet 430RS.

Important Safety Information For All Users

This is a Class 1 laser product meeting laser safety requirements of 21 CFR 1040 and EN60825-1 as applicable. Laser devices contained within this equipment are hazardous. All procedures necessary to perform user functions are outlined in this document. Internal lasers have the following output characteristics under maximum conditions:

Laser Type	Wavelength (nm)	Output Power (mW)	Beam Divergence (mRad)
Helium Neon (HeNe) Red Laser:	633	14	1.4
Helium Neon (HeNe) Green Laser:	543	1.7	1.0
Argon (Ar+) Blue Laser:	458	2.5	1.0

Table 1-1. LightJet 430 laser specifications

CAUTION DANGER: LASER RADIATION: THIS EQUIPMENT WILL EMIT LASER RADIATION WHEN OPEN AND INTERLOCK SWITCHES DEFEATED. AVOID EYE EXPOSURE TO DIRECT AND SCATTERED LASER RADIATION.

DANGER: RADIATIONS LASER: CET ÉQUIPEMENT PEUT ÉMETTRE DES RADIATIONS LASER LORSQU'IL EST OUVERT ET EN CAS DE DÉFAILLANCE DES INTERRUPTEURS DE SÉCURITÉ. ÉVITER TOUT CONTACT DES YEUX AUX RAYONS DIRECTS ET INDIRECTS DES LASERS.

GEFAHR: LASERSTRAHLUNG: IM OFFENEM ZUSTAND UND MIT ÜBERBRÜCKTEN SICHERUNGSSCHALTERN WIRD VON DIESEM GERÄT LASERSTRAHLUNG EMITTIERT. VERMEIDEN SIE DIE BESTRAHLUNG DER AUGEN DURCH DIREKTE ODER GETREUTE LASERSTRAHLUNG.

CAUTION CAUTION: USE OF CONTROL OR ADJUSTMENTS OR PERFORMANCE OF PROCEDURES OTHER THAN THOSE SPECIFIED HEREIN MAY RESULT IN HAZARDOUS LASER RADIATION EXPOSURE.

ATTENTION: LE CONTRÔLE ET L'AJUSTEMENT AINSI QUE LA MODIFICATION DES PERFORMANCES AUTRES QUE CEUX STIPULÉS DANS CE MANUEL PEUVENT CRÉER DES EFFETS IMPRÉVUS DE LA RADIATION LASER.

VORSICHT: ANDERE, ALS HIER VORGESCHRIEBENE, BENUTZUNG VON KONTROLLSCHALTERN, JUSTIERUNGEN UND DURCHFÜHRUNG VON VORSCHRIFTEN, KANN ZU GEFÄHRLICHER BESTRAHLUNG FÜHREN.

Getting Familiar With Your LightJet® 430

NOTE The LightJet 430 is a digital photo printer intended for operation under conditions of a controlled environment. Photo printers are classified as information technology equipment (ITE), and are subject to applicable ITE test and working environment standards. Deployment of this equipment in an environment or under conditions other than specified and/or recommended may result in degradation of machine performance.

Overview

The LightJet 430 is a wide format digital photo printer capable of producing large photographic quality images on various paper and film materials from several data formats.

The LightJet 430 is a self-contained unit (Figure 1-1) that must be located in a darkroom to allow for loading and unloading of photographic media. Once the media is loaded, the printer can operate in a normally lighted environment. It functions as a computer peripheral and therefore must be configured as part of a computer system, similar to a standard printer.

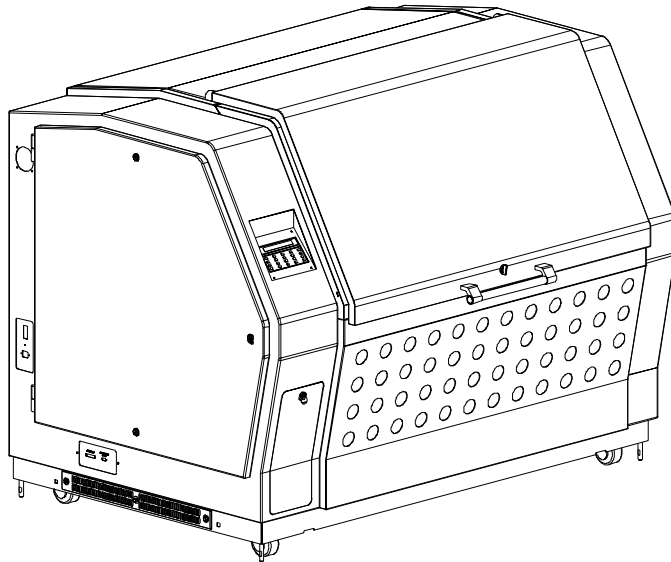

Figure 1-1. Exterior view.

Features

The main features of the LightJet 430 include:

- Simple operation, maintenance and repair
- Daylight operation except when loading or unloading media
- Standard Resolutions – 200 and 300 dpi
- Maximum Image Length of 306 cm (120.5")
- “On the fly” image size interpolation and sharpness control
- Definable borders or full bleed printing

Supported Media Specifications

The LightJet 430 can image on the following media types and sizes:

Supported RA4 Media Types			
	Paper	Trans	Flex
Supported Length (maximum):	50 m (164")	30.5 m (100')	30.5 m (100')
Supported Widths for All Three Media Types			
76.2 cm (30")	81.3 cm (32")	101.6 cm (40")	127 cm (50")

Table 1-2. Supported media dimensions.

Océ Display Graphics Systems and/or the respective media manufacturer have tested and authorized the use of certain media materials. These materials have been certified to perform at acceptable levels on a properly functioning system. Please consult the FTP site at <http://www.cymbolic.com/ftp.html> for a current list of qualified media.

End of Section

THIS PAGE INTENTIONALLY LEFT BLANK

2 Operating the LightJet® 430

Powering On and Off

The LightJet 430 has an AC power circuit breaker switch located on the left hand side of the printer. To power on:

1. Ensure the LightJet 430 is properly plugged into the correct wall outlet.
2. Turn on the AC power circuit breaker. The control panel displays “OFF LINE”.
3. Press the  ON LINE key to place the printer on-line. A reset is performed and the power-up tests are completed.

To power off:

1. Unload and remove all media from the printer.
2. Turn the power circuit breaker off; system cooling fans and blower should remain on.
3. Ensure that the internal blower continues to operate for about 10 minutes to allow the blue laser to cool down. In the event that the blower does not continue to operate, turn the power circuit breaker back on and contact Océ (see “Product Support, Documentation and Service” on page iii).

Media Handling

Media handling can impact image results. Adherence to the following recommendations will help ensure consistent image quality.

- Check expiry dates. Media used after the expiry date will yield poor results.
- Store in a refrigerator for short term storage (such as over the weekend) and in a freezer for long term storage.
- Exposed media should be stored in a refrigerator if it is not processed for a few days, such as over a weekend.
- Media removed from the refrigerator or freezer must be allowed to thermally stabilize, reaching room temperature before use.
- Handle media with clean hands and lint free gloves. Oil deposits from fingers will degrade image quality.

Before loading the media, prepare a table surface in the printer room with everything you will need to perform the task, including lint free gloves, tape, supply of media, media roll flanges, and media transfer tube.

A light-tight room is essential to prevent the media from becoming fogged. It may not be immediately apparent if the media has been fogged. Unexplained variations in density and color casts could be the result of slight fogging.

Loading and unloading media is performed through a single access door at the front of the machine. A set of moveable guides are used to guide the media along the inside surface of the imaging drum. The media is held against the drum surface by a small compressive load.

Control Panel

The LightJet 430 operator control panel is illustrated in Figure 2-1.

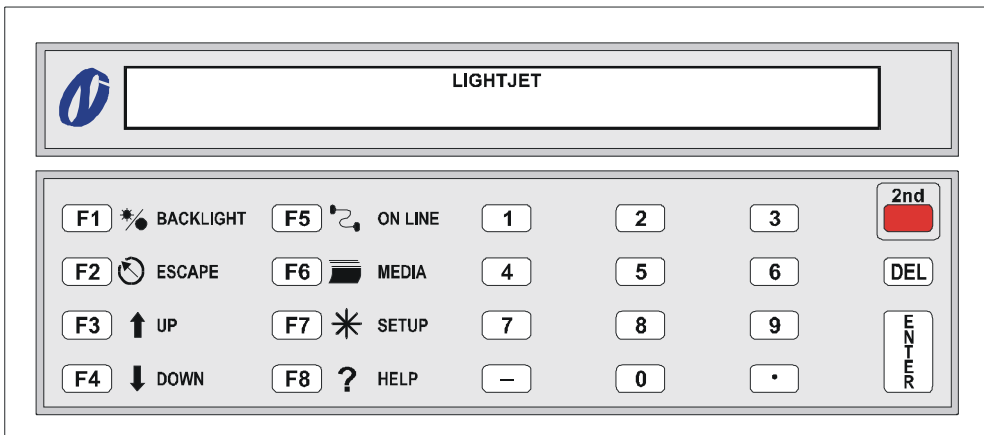







Figure 2-1. Control panel.

There are 10 function keys on the control panel that operate as follows:

 BACKLIGHT	Toggles the display light on and off.
 ESCAPE	Allows you to go back to a previous menu or abort an operation. The display will indicate when this key is active by listing it in the option line.
 UP	Used to scroll up through the options.
 DOWN	Used to scroll down through the options.
 ON LINE	Used to toggle between on-line and off-line modes. When on-line, all key functions are disabled except for the backlight key.





 MEDIA	Opens the Media Menu, which provides the options required for everyday operation of the LightJet 430.
 SETUP	Opens the Setup Menu, which is primarily a service tool that performs various activities normally used for test purposes.
 HELP	Currently not in use.
DEL(ETE)	Deletes numerical entries from the control panel.
ENTER	Activates/opens the selected option, or confirms that activities have been performed.

Table 2-1. Functions of the control panel keys.

Activating Options

With the printer off-line, press the  **MEDIA** or  **SETUP** to enter the Media or Setup menus, as follows:

1. If the printer is on-line, press the  **ON LINE** key to take it off-line. The control panel displays¹:



PRINTER OFF LINE
 <ON LINE, MEDIA, SETUP>

2. Press the  **MEDIA** key to enter the Media Menu. The control panel displays²:

MEDIA FUNCTIONS: Load New Roll?
 <ENTER to load, v, ^>



3. Press the  **SETUP** key to enter the Setup Menu. The control panel displays:

SETUP FUNCTIONS: Motor Control
 <ENTER to view status, v, ^>

4. Scroll through the options using the  **UP** and  **DOWN** keys.

Notes:

¹ Text that appears between the < and > characters on the second line of the control panel display indicates keys and/or functions that are currently available/active.

² The v and ^ characters represent the  **UP** and  **DOWN** scroll keys.

5. Press the **ENTER** key to activate the currently displayed option.

Media Menu

Options in the Media Menu:

- Load New Roll?
- Advance Media?
- Cut and Unload?

Use the **↑ UP** and **↓ DOWN** keys to toggle between the options.

Load New Roll

“Load New Roll?” is used to load a new roll of media. This “Load New Roll?” instruction assumes that all previously loaded media has been unloaded. To load a new roll of media¹:

6. Obtain an empty media spool of the correct size and attach a spool flange to each end as shown in Figure 2-2.

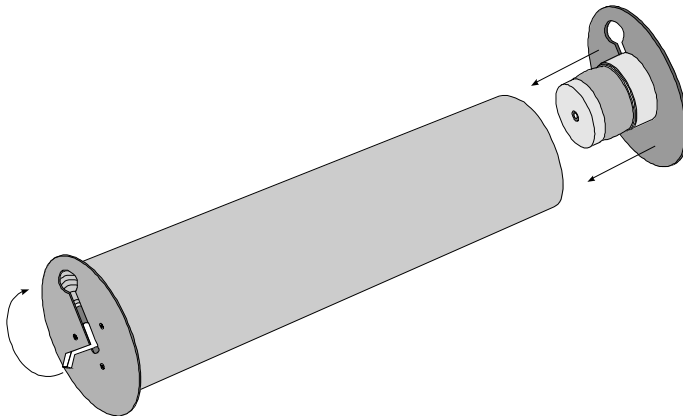

Figure 2-2. Attaching spool flanges to a media roll.

7. Open the media door and place the empty media roll on the outfeed drive rollers. Ensure the left flange is in the appropriate media roll guide (Figure 2-3).

Notes:

¹ Error conditions may be reported by the control panel while performing this function. If errors do occur, press the enter key to view the error(s) and then refer to “Control Panel Error Conditions” in the LightJet® 430 Maintenance Manual (part #45574) for detailed information and corrective actions. Maintenance procedures may only be performed by qualified maintenance personnel.

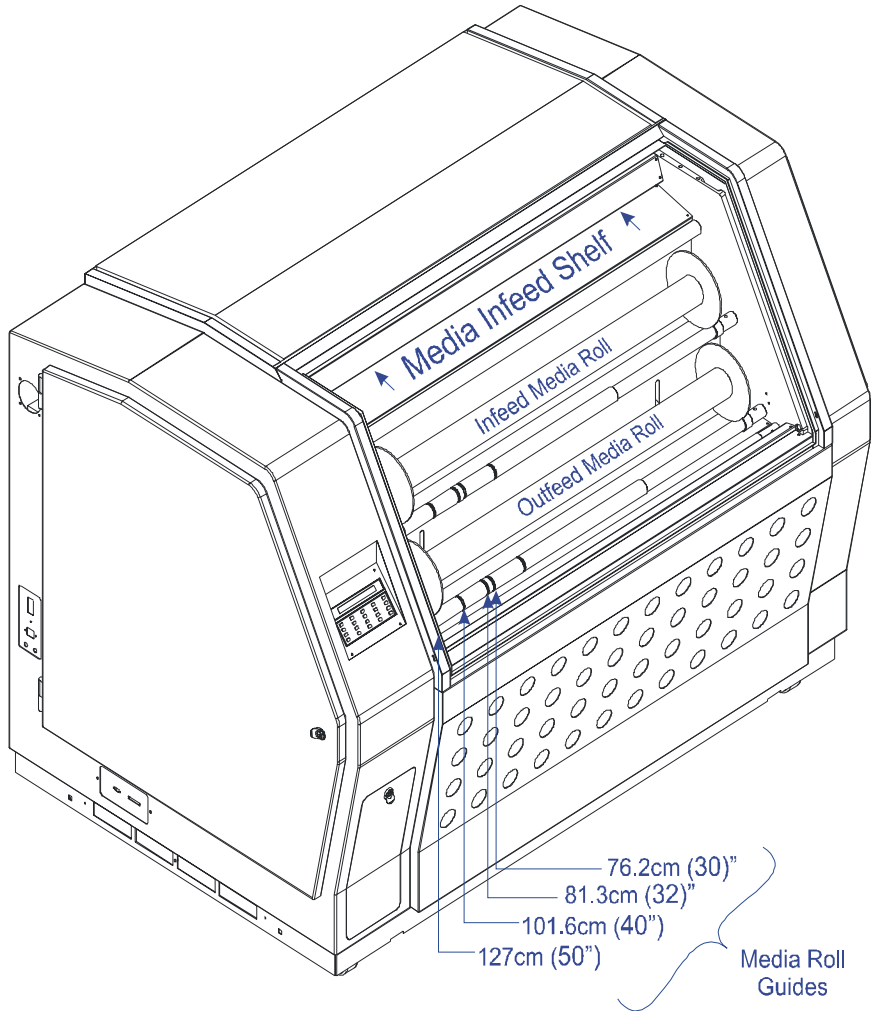

Figure 2-3. Loading media.

8. As shown in Figure 2-4, there are two pinch levers. Ensure the pinch is closed by pulling each lever toward you.

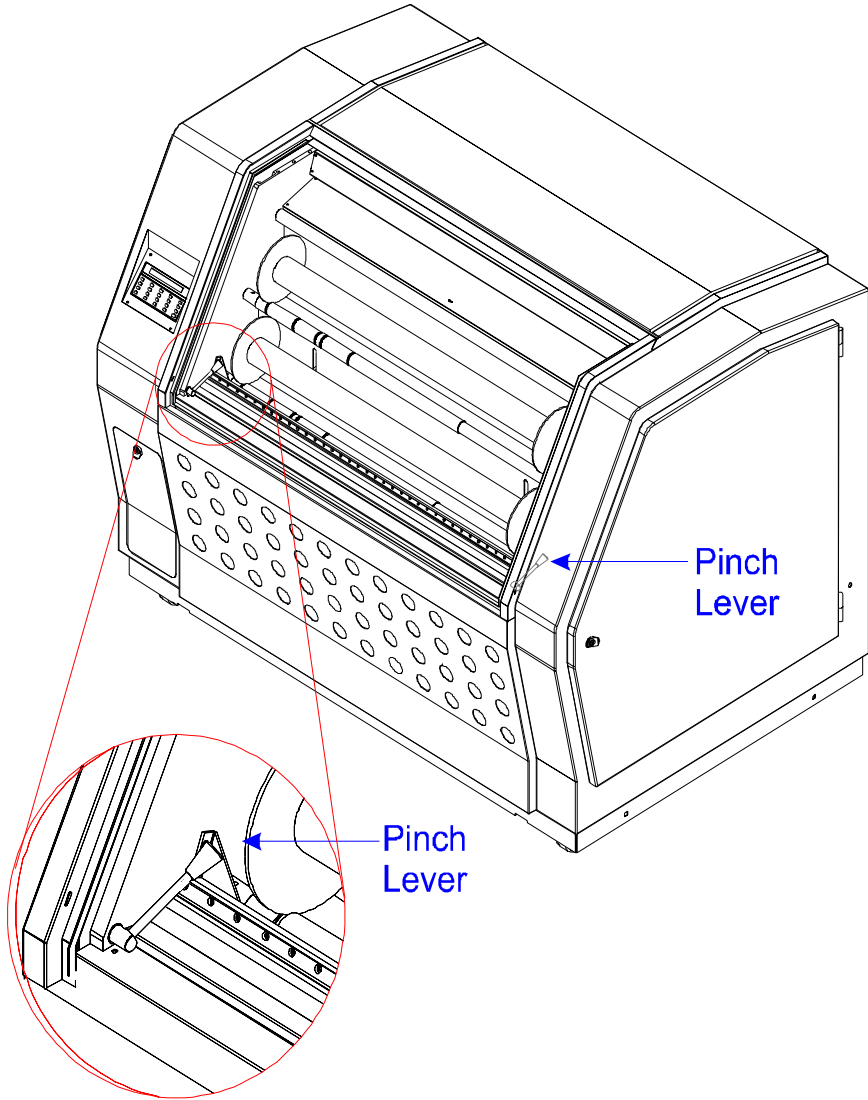

Figure 2-4. Pinch lever.

9. Enter the Media Menu and activate “Load New Roll?”. The control panel displays:

Media Width to Load is.....XX”

Scroll for Options Enter/Accept ESC/Quit

10. Scroll through the supported media widths using the **↑ UP** and **↓ DOWN** keys. The current Width is displayed instead of the XX shown above. When the correct width is displayed, press **ENTER**. The control panel displays:

Media Type to Load is.....XXXX

Scroll for Options Enter/Accept ESC/Quit

11. Scroll through the supported media types using the **↑ UP** and **↓ DOWN** keys. The current Type is displayed instead of the XXXX shown above. When the correct type is displayed press **ENTER**. The control panel displays:

Preparing system to load media...

and then:

Load media into infeed pinch

Press ESC to quit

12. Press the *** BACKLIGHT** key to turn off the control panel light.
13. Turn the lights out in the room.
14. While in the dark, remove the media from its container.
15. Attach a spool flange to each end of the media roll.
16. With the emulsion side down (the roll feeding from the top), place the left spool flange of the media roll in the appropriate media roll guide as shown in Figure 2-4.
17. Remove any tape from the leading edge of the media roll being loaded.
18. Place the leading edge of the media squarely onto the input shelf. Press down and forward, pushing it along, until it reaches the first set of Infeed pinch rollers. You will feel the media being pulled into the media transport¹.

Notes:

¹ There is a 30 second time-out on feeding the media. If the LightJet® 430 times out, you will be returned to the main media functions menu.



19. After about 30 seconds the media will be driven out of the output pinch and stop. The control panel will beep (1 beep every 2 seconds), indicating that the media is ready to be taped to the empty media roll.
20. Verify that the leading edge of the media is centered between the output spool flanges. If the media is not centered:
 - Open the output pinch by pushing pinch levers forward.
 - Center the media, grab the sides of the media with your fingers and shift it side to side. Do not pull on the media.
 - Close the pinch levers. The LightJet 430 will beep (1 beep per second) if the pinch levers are not closed.
21. Attach the end of the media securely to the output roll using a piece of adhesive tape. Ensure the media is fed onto the outfeed roll such that the emulsion is facing in on the roll.
22. Close the media door. You may now turn the room lights on.
23. Press the  BACKLIGHT key to turn on the control panel light. The control panel should read:

Tape Media to take-up roll
Press Enter to confirm

24. Press the **ENTER** key to confirm that the media has been taped to the output roll; the printer will automatically go on-line.

Advance Media

Although media is advanced after every image (unless otherwise specified by the host software), there are some cases where you may wish to advance the media manually. To manually advance media:

25. Enter the Media Menu and use the  **UP** and  **DOWN** keys to locate “Advance Media?”. The control panel displays:

MEDIA MENU Advance Media?
<ENTER to advance, v, ^>

26. Enter the length of the advance in inches; the control panel displays the entered value.
27. Press the **ENTER** key to advance the media.

The media advances the prescribed length, then the printer automatically goes on-line.

Cut and Unload

“Cut and Unload?” allows you to cut the media and remove the images on the output role for storage or processing. After cutting is complete you may either:

- Continue using the currently loaded media by advancing the role for taping
- or*
- Re-wind the loaded media onto the infeed roll to unload it.

To cut and unload ¹:

1. Enter the Media Menu and activate “Cut and Unload?”. The control panel displays:

Advancing Media...

and then:

Cut media now
Press Enter when finished

2. The machine beeps (1 beep then 2 beeps, repeating) when the media is to be cut. Cut the media and then press the **ENTER** key to confirm. The control panel displays:

Next Media State?
Tape to Roll <Enter> Unload Media <Esc>

3. Unload the imaged media. Replace the outfeed roll with an empty roll.
4. Press the **ENTER** key to advance the media and tape it to the outfeed roll. Press  **ESCAPE** to rewind the infeed roll for unloading.

Notes:

¹ Error conditions may be reported by the control panel while performing this function. If errors do occur, press the enter key to view the error(s) and then refer to “Control Panel Error Conditions” in the LightJet® 430 Maintenance Manual (part #45574) for detailed information and corrective actions. Maintenance procedures may only be performed by qualified maintenance personnel.

Setup Menu

The Setup Menu options provide a tool for testing subsystems and setting up certain operational parameters. The customer is not expected to use the Setup Menu on a day-to-day basis. The options in the Setup Menu are:

- Motor Control
- Video Control
- Internal Plot?
- Debug Mode?
- Download Firmware?
- Cleaning Mode

Motor Control

Motor Control is used primarily by service engineers. This function operates the media transport motors, either forwards or backwards by a set number of inches. It is important to remember that Motor Control operates with no regard for the placement of the media guides and lightshield or whether or not media is loaded. For this reason, use of this function requires extreme care to avoid damage to internal components.

Video Control

Video Control turns on each laser independently at different power levels. This function is used for test purposes by service engineers only.

Internal Plot

Internal Plot allows you to print an image without input from a host computer. This can be useful in determining if a problem originates with the host computer or the LightJet 430. To print the internal image:

1. Enter the Setup Menu and activate Internal Plot. The LightJet 430 immediately begins printing the internal image and the control panel displays “Internal Plot Activated”. Once initiated, there is no way to stop the print. When the print is complete the control panel displays:

<p>PRINTER OFF LINE <ON LINE, MEDIA, SETUP></p>

2. Press the  ON LINE key to put the printer on-line.

Debug Mode

Debug Mode allows control panel functions to be controlled by a terminal interface at the host computer, for test purposes by service engineers only.

Download Firmware

The Download Firmware function is used to put the LightJet 430 in an operational mode that allows new firmware to be downloaded from the host computer. Once the printer is put in this mode, it will not respond to any other commands until the new firmware is downloaded.¹ To put the LightJet 430 in Download Firmware mode enter the Setup Menu and activate Download Firmware. The control panel goes blank.

Cleaning Mode

Cleaning Mode allows you to access and clean specific parts of the machine. It presents you with the following options:

- Clean Output Rollers
- Clean Drum
- Clean Light Shield

Refer to the LightJet 430 Maintenance Manual (#45574) for instructions on performing these cleaning procedures.

End of Section

Notes:

¹ If firmware is not downloaded after the printer is put in the “Download Firmware” mode, the machine must be powered down and then back up to recover.

THIS PAGE INTENTIONALLY LEFT BLANK